

Article number: 203160M1080B1S

Description: E+G levelling foot
GN 31-60-M10-80-B1-S

Note: S Without nut, External hexagon at the bottom

Measures

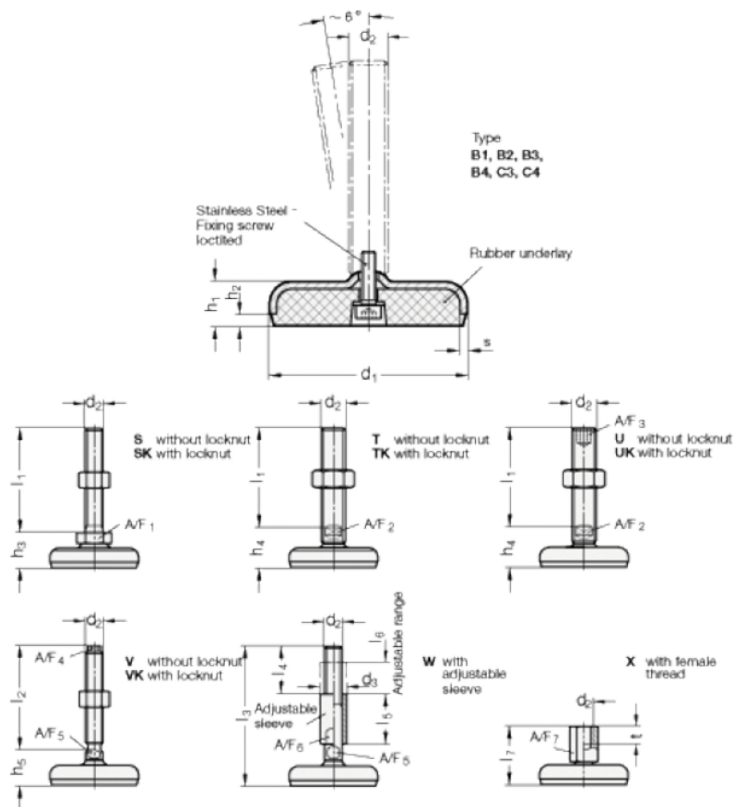

A/F1-	= 17
d1	= 60
d2	= 10
h1	= 16
h2	= 4
h3 +4.0/0	= 26
l1	= 80
s	= 3